

AIR/HYDRAULIC SHOP PRESSES

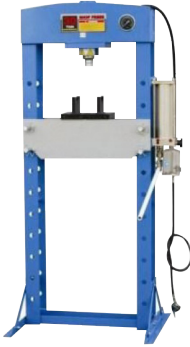

SD080CEA

CAPACITY:	30T	RAM STROKE:	150MM
SIDE STROKE:	200MM	WORKING RANGE:	151-1031MM
BED WIDTH:	535MM	AIR PRESSURE:	0.75-0.85MPA
AIR INLET:	1/4"NPT	N.W:	171KG
G.W:	207KG		

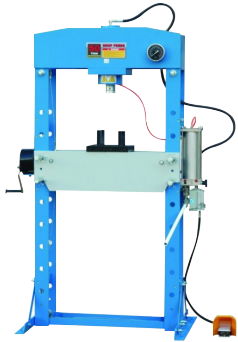

SD0811CE

CAPACITY:	50T	RAM STROKE:	200MM
SIDE STROKE:	245MM	WORKING RANGE:	69-1048MM
BED WIDTH:	730MM	AIR PRESSURE:	0.75-0.85MPA
AIR INLET:	1/4"NPT	N.W:	302.4KG
G.W:	344KG		

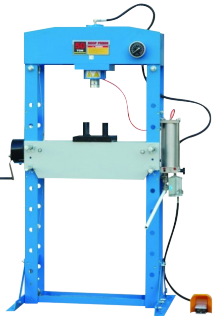

SD0812CE

CAPACITY:	75T	RAM STROKE:	250MM
SIDE STROKE:	260MM	WORKING RANGE:	170-884MM
BED WIDTH:	800MM	AIR PRESSURE:	0.75-0.85MPA
AIR INLET:	1/4"NPT	N.W:	451KG
G.W:	497KG		



SD080CEA

CAPACITY:	100T	RAM STROKE:	300MM
SIDE STROKE:	250MM	WORKING RANGE:	93-993MM
BED WIDTH:	787MM	AIR PRESSURE:	0.75-0.85MPA
AIR INLET:	1/4"NPT	N.W:	662KG
G.W:	766KG		

AIR-IMPACT LTD

See more at: www.airimpact.ie

Thurles Contact: (0504) 21622
(0504) 21490

Dublin Contact: (01) 4565776

AIR/HYDRAULIC SHOP PRESSES

AIR SHOP PRESS FEATURES

- 2 holes in each foot to fix in the floor.
- Steel frame.
- 2 step stroke system.
- Closed: Full stroke for quick approach.
- Open: Small stroke for fine tuning of the load.
- Large gauge measuring short and metric tons.
- Delivered with 2 V blocks.
- Easy to use handle with rubber grip.

AIR SHOP PRESS BENEFITS

- High stability.
- Durable & sturdy.
- Easy and precise control.
- Stability.

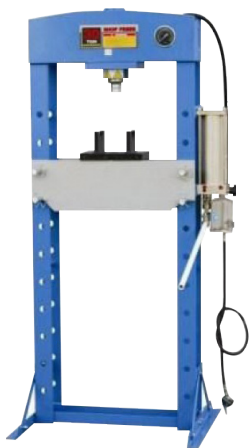
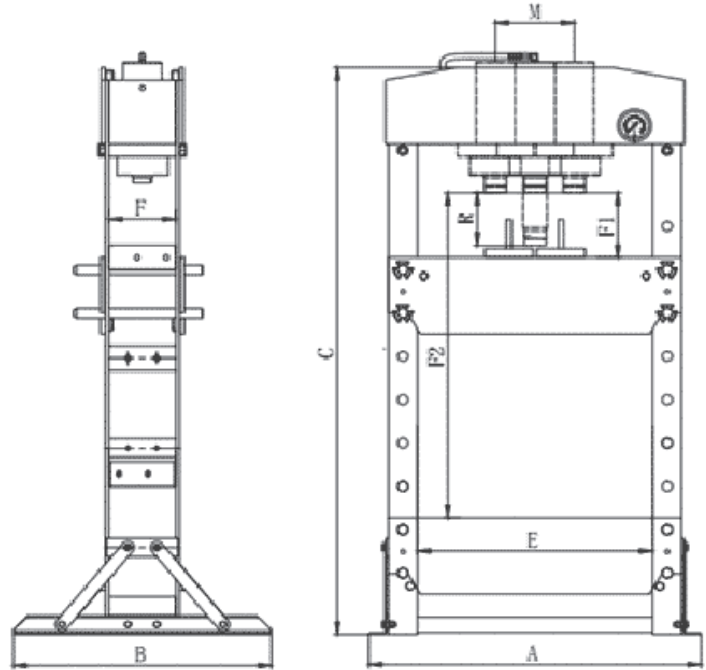

SD0808CEA

CAPACITY:	30T	RAM STROKE:	150MM
DIMENSION A:	795 MM	SIDE STROKE:	200MM
DIMENSION B:	700 MM	BED WIDTH:	535MM
DIMENSION C:	1772 MM	WORKING RANGE:	151-1031MM
DIMENSION E:	535 MM	AIR PRESSURE:	0.75-0.85MPA
DIMENSION F:	140 MM	AIR INLET:	1/4"NPT
DIMENSION F1:	151MM	N.W:	171KG
DIMENSION F2:	1031 MM	G.W:	207KG
DIMENSION M:	200MM	OIL CAPACITY:	1.1ML
DIMENSION R	160MM		

AIR-IMPACT LTD

Thurles Contact: (0504) 21622
(0504) 21490

Dublin Contact: (01) 4565776

See more at: www.airimpact.ie
info@airimpact.ie

AIR/HYDRAULIC SHOP PRESSES

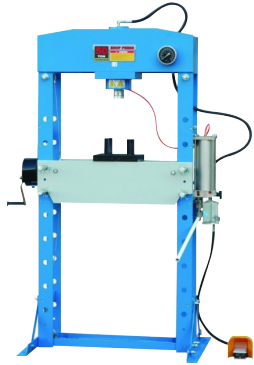

SD0811CE

CAPACITY:	50T	RAM STROKE:	200MM
DIMENSION A:	1030MM	SIDE STROKE:	245MM
DIMENSION B:	800MM	WORKING RANGE:	69-1048MM
DIMENSION C:	1830MM	BED WIDTH:	730MM
DIMENSION E:	730MM	AIR PRESSURE:	0.75-0.85MPA
DIMENSION F:	207MM	AIR INLET:	1/4"NPT
DIMENSION F1:	68MM	N.W:	302.4KG
DIMENSION F2:	1048MM	G.W:	344KG
DIMENSION M:	245MM	OIL CAPACITY:	2.5ML
DIMENSION R:	200MM		

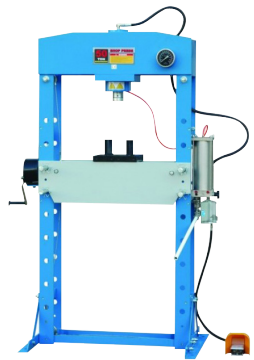

SD0812CE

CAPACITY:	75T	RAM STROKE:	250MM
DIMENSION A:	1140MM	SIDE STROKE:	260MM
DIMENSION B:	800MM	WORKING RANGE:	170-884MM
DIMENSION C:	1840MM	BED WIDTH:	800MM
DIMENSION E:	800MM	AIR PRESSURE:	0.75-0.85MPA
DIMENSION F:	245MM	AIR INLET:	1/4"NPT
DIMENSION F1:	170MM	N.W:	451KG
DIMENSION F2:	884MM	G.W:	497KG
DIMENSION M:	260MM	OIL CAPACITY:	4.5ML
DIMENSION R:	250MM		



SD0813CE

CAPACITY:	100T	RAM STROKE:	300MM
DIMENSION A:	1200MM	SIDE STROKE:	250MM
DIMENSION B:	900MM	WORKING RANGE:	93-993MM
DIMENSION C:	1830MM	BED WIDTH:	787MM
DIMENSION E:	787MM	AIR PRESSURE:	0.75-0.85MPA
DIMENSION F:	300MM	AIR INLET:	1/4"NPT
DIMENSION F1:	114MM	N.W:	662KG
DIMENSION F2:	814MM	G.W:	766KG
DIMENSION M:	235MM	OIL CAPACITY:	5.6ML
DIMENSION R:	300MM		

AIR-IMPACT LTD

Thurles Contact: (0504) 21622
(0504) 21490

Dublin Contact: (01) 4565776

See more at: www.airimpact.ie
info@airimpact.ie